



Sheer
Driving Pleasure



THE NEW BMW 1 SERIES. 3-DOOR AND 5-DOOR.

BMW EFFICIENT DYNAMICS.
LESS EMISSIONS. MORE DRIVING PLEASURE.

THE NEXT
100 YEARS



THE NEW BMW 1 SERIES. 3-DOOR AND 5-DOOR.



M PERFORMANCE

DIGITAL DISCOVERY: THE NEW BMW BROCHURES APP.



More information, more driving pleasure: The new BMW brochures app offers you a brand new digital and interactive BMW experience. Download the BMW brochures app for your smartphone or tablet now and explore new perspectives of your BMW.

INNOVATION AND TECHNOLOGY.



18 BMW EfficientDynamics



20 BMW ConnectedDrive



22 Suspension and safety

EQUIPMENT.



24 Models and Lines



32 Equipment highlights



36 Exterior colours

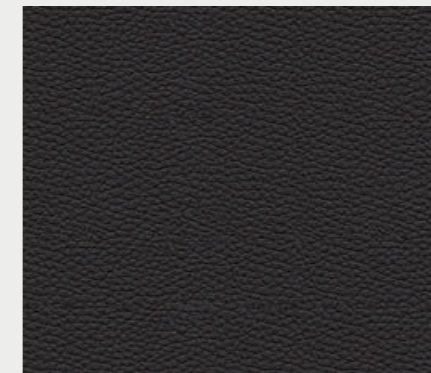

38 Interior colours



40 Wheels and tyres



41 Original BMW Accessories

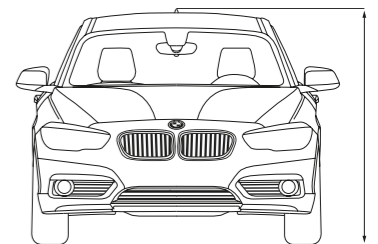

42 Technical data



INSTIGATOR.

CONNECTED TO PERFORM.





CHANGE THE CITY IMAGE.

EXEMPLARY DRIVING DYNAMICS THANKS TO ADAPTIVE M SUSPENSION* AND BMW xDRIVE II VARIABLE SPORT STEERING* FOR PRECISE STEERING RESPONSE II LIGHT GEARSHIFTS WITH OPTIMISED 8-SPEED STEPTRONIC SPORT TRANSMISSION* II TOP EFFICIENCY THANKS TO BMW TWIN POWER TURBO TECHNOLOGIES AND ECO PRO MODE II WITH DRIVING ASSISTANT* FOR ENHANCED SAFETY





DESIGN RELOADED.

NEW INTERIOR DESIGN WITH OPTIMISED CENTRE CONSOLE AND DASHBOARD || NEWLY POSITIONED AIR OUTLETS || INTERIOR TRIM FINISHERS ALUMINIUM HEXAGON WITH HIGHLIGHT TRIM FINISHERS BLACK HIGH-GLOSS* || ADAPTIVE LED HEADLIGHTS* || SEAMLESSLY CONNECTED DESIGN ELEMENTS AND PERFECTLY INTEGRATED SURFACES

* Available as optional equipment.



ALWAYS CONNECTED: WHEREVER YOU ARE.

INNOVATIVE: PERSONALISABLE USER INTERFACE WITH TOUCH SCREEN* || INTUITIVE: NEW, INTELLIGENT OPERATING CONCEPT* || COOPERATIVE: NUMEROUS CONNECTED DRIVE SERVICES* || BMW CONNECTED* || INTERACTIVE: COMPREHENSIVE ONLINE AND ENTERTAINMENT FUNCTIONS*

* Available as optional equipment.



MORE ADRENALIN PER KILOMETRE.

BMW M140i xDRIVE WITH M PERFORMANCE TWIN POWER
TURBO INLINE 6-CYLINDER PETROL ENGINE II SPECIALLY
TUNED SUSPENSION II FROM 0 TO 100 KM/H IN 4.4 SECONDS II
250 KW (340 HP) II 500 NM OF TORQUE



DYNAMICS EN MASSE.

PASSIONATELY ATHLETIC EXTERIOR DESIGN || LONG WHEELBASE ||
SHORT OVERHANGS || BROAD, LOW STANCE ON THE ROAD ||
NEW EDITIONS WITH EXCLUSIVE BLACK DESIGN ACCENTS* || NEW
EXTERIOR COLOURS*

* Available as optional equipment.



DRIVING FUN THAT NEVER ENDS.

FROM START TO FINISH – THE PLEASURE'S ALL YOURS. WHETHER IT'S A CASUAL CRUISE OR A SPORTY SPRINT, THE NEW BMW 1 SERIES CAN DO EVERYTHING THAT YOUR HEART DESIRES. IT BOASTS EXCEPTIONAL AGILITY BOTH IN THE CITY AND OUT IN THE COUNTRY, DISPLAYING THE VERY BEST IN DYNAMICS AND EFFICIENCY. THE COMPREHENSIVE INTERCONNECTIVITY BETWEEN DRIVER; VEHICLE AND OUTSIDE WORLD, NOT TO MENTION INTELLIGENT DRIVING ASSISTANCE SYSTEMS, GUARANTEE UNIQUE DRIVING COMFORT, THE ULTIMATE IN SAFETY; AND MOST IMPORTANTLY: UNBOUNDED DRIVING PLEASURE – TIME AND TIME AGAIN.

www.bmw.com/efficientdynamics

MORE POWER FROM LESS FUEL.

More power from 3 to 12 cylinders. Consume less, experience more – the **BMW TwinPower Turbo engines** offer the greatest possible dynamic performance with the greatest possible efficiency thanks to the newest injection systems, variable output control and sophisticated turbocharger technology. Whether diesel or petrol, and no matter how many cylinders, the engines from the BMW EfficientDynamics engine family allow markedly more agile power delivery and outstanding responsiveness even at low rpms, while being fuel-efficient and low in emissions.

MORE DRIVING PLEASURE, LESS EMISSIONS.

Approximately 33% less CO₂ emissions since 2000: **BMW EfficientDynamics** is a technology package that includes not only the drive, but rather the whole vehicle concept and intelligent energy management. Provided as standard in every BMW, a variety of innovative technologies contribute to continuously improving efficiency. Via engine efficiency measures, electrification, lightweight construction methods and optimised aerodynamics, BMW has managed to reduce the CO₂ emissions of its fleet by 33%.

MORE SPEED, LESS WEIGHT.

Lower weight with intelligent lightweight construction. Special consideration for every last detail – intelligent lightweight construction means that the optimal material is found and implemented for each part of the vehicle. With extremely light high-tech materials such as aluminium and carbon fibre, **BMW EfficientLightweight** is pursuing the goal of minimising vehicle weight. That leads to even more dynamic performance, increased stability and heightened vehicle safety and comfort.



DRIVING EXPERIENCE CONTROL

Driving Experience Control offers the driver the choice between the standard COMFORT mode, the more efficient ECO PRO mode, and the SPORT and SPORT+¹ modes, for an even more dynamic drive. ECO PRO mode adjusts the characteristics of the Steptronic transmission (if present) and the heating/air conditioning settings to make the drive as fuel-efficient as possible.

BMW EFFICIENT LIGHTWEIGHT

Intelligent lightweight construction at BMW means using the right material for the right parts of the vehicle. For every single component, the most suitable material is selected. This philosophy, also known as BMW EfficientLightweight, is now integral to BMW EfficientDynamics and applied to every BMW.

AUTOMATIC START/STOP FUNCTION

The Automatic Start/Stop function switches off the engine when the vehicle comes to a temporary standstill (e.g. at traffic lights or in a traffic jam), which can reduce overall fuel consumption. When the driver presses down on the clutch (manual transmission) or takes their foot off the brake (Steptronic transmission), the engine automatically starts up again in a fraction of a second.

THE NEW BMW 1 SERIES – DYNAMIC AND EFFICIENT.



BMW 116i

- BMW TwinPower Turbo 3-cylinder petrol engine with 80 kW (109 hp) and 180 Nm torque
- Acceleration 0–100 km/h: 10.9 s; top speed: 195 km/h
- Combined fuel consumption: 5.0–5.4 l/100 km
- CO₂ emissions combined: 116–126 g/km

BMW 118i

- BMW TwinPower Turbo 3-cylinder petrol engine with 100 kW (136 hp) and 220 Nm torque
- Acceleration 0–100 km/h: 8.5 [8.7] s; top speed: 210 [210] km/h
- Combined fuel consumption: 5.0–5.4 [4.8–5.2] l/100 km
- CO₂ emissions combined: 116–126 [112–122] g/km

BMW 120i

- BMW TwinPower Turbo 4-cylinder petrol engine with 135 kW (184 hp) and 290 [270] Nm torque
- Acceleration 0–100 km/h: 7.1 [7.1] s; top speed: 230 [225] km/h
- Combined fuel consumption: 5.7–6.1 [5.5–5.9] l/100 km
- CO₂ emissions combined: 131–140 [126–135] g/km

BMW 125i

- BMW TwinPower Turbo 4-cylinder petrol engine with 165 kW (224 hp) and 310 Nm torque
- Acceleration 0–100 km/h: [6.1] s; top speed: [243] km/h
- Combined fuel consumption: [5.7–5.9] l/100 km
- Combined CO₂ emissions: [130–134] g/km

BMW M140i/M140i xDrive

- M Performance TwinPower Turbo 6-cylinder petrol engine with 250 kW (340 hp) and 500 Nm torque
- Acceleration 0–100 km/h: 4.8 [4.6] s (xDrive: [4.4] s); top speed: 250 [250] km/h (xDrive: [250] km/h)
- Combined fuel consumption: 7.8 [7.1] l/100 km (xDrive: [7.4] l/100 km)
- Combined CO₂ emissions: 179 [163] g/km (xDrive: [169] g/km)

BMW 114d

- BMW TwinPower Turbo 3-cylinder diesel engine with 70 kW (95 hp) and 235 Nm torque
- Acceleration 0–100 km/h: 12.2 s; top speed: 185 km/h
- Combined fuel consumption: 3.6–4.0 l/100 km
- CO₂ emissions, combined: 95–106 g/km

BMW 116d

- BMW TwinPower Turbo 3-cylinder diesel engine with 85 kW (116 hp) and 270 Nm torque
- Acceleration 0–100 km/h: 10.3 [10.3] s; top speed: 200 [200] km/h
- Combined fuel consumption: 3.7–4.1 [3.6–4.1] l/100 km
- Combined CO₂ emissions: 97–107 [96–107] g/km

BMW 118d/118d xDrive

- BMW TwinPower Turbo 4-cylinder diesel engine with 110 kW (150 hp) and 320 Nm torque
- Acceleration 0–100 km/h: 8.3 [8.1] s (xDrive: 8.4 s); top speed: 212 [212] km/h (xDrive: 210 km/h)
- Combined fuel consumption: 4.0–4.3 [3.8–4.2] l/100 km (xDrive: 4.3–4.7 l/100 km)
- CO₂ emissions combined: 104–114 [99–110] g/km (xDrive: 113–123 g/km)

BMW 120d/120d xDrive

- BMW TwinPower Turbo 4-cylinder diesel engine with 140 kW (190 hp) and 400 Nm torque
- Acceleration 0–100 km/h: 7.1 [7.0] s (xDrive: [6.8] s); top speed: 228 [228] km/h (xDrive: [222] km/h)
- Combined fuel consumption: 4.1–4.5 [3.9–4.3] l/100 km (xDrive: [4.3–4.7] l/100 km)
- CO₂ emissions combined: 108–118 [103–114] g/km (xDrive: [113–124] g/km)

BMW 125d

- BMW TwinPower Turbo 4-cylinder diesel engine with 165 kW (224 hp) and 450 Nm torque
- Acceleration 0–100 km/h: [6.3] s; top speed: [240] km/h
- Combined fuel consumption: [4.3–4.6] l/100 km
- Combined CO₂ emissions: [114–121] g/km

¹ Only available in conjunction with additional equipment.

Quoted performance, fuel consumption and CO₂ emissions figures refer to vehicles with standard transmission. Figures in [] refer to vehicles with Steptronic transmission.

Fuel consumption and CO₂ emissions are dependent on the selected tyre format (higher figures refer to models with optional wheels). Further information on fuel consumption and CO₂ emissions can be found in technical data or consult your local BMW partner.

REGISTERS UP TO **360** DEGREES
OF THE VEHICLE'S SURROUNDINGS.

Enjoy the greatest convenience and the highest level of safety with the BMW Personal CoPilot. For driving, parking and visibility, you can rely on BMW Personal CoPilot driver assistance systems in every situation. The most cutting-edge systems, such as radar, ultrasound and cameras, dependably register the vehicle's surroundings, forming the basis for intelligent driver assistance systems. Either activated when desired, or as emergency assistance in the background – BMW Personal CoPilot assistance systems make every drive in your BMW even safer and more enjoyable.

**CONNECTED FOR
OVER 40 YEARS.**

Focused on the future – from the very beginning. By the 1970s, BMW had already made headway in connected mobility. Another milestone of the digital future was surpassed in 1999: vehicles with built-in SIM cards. Then came the first online functionality, Google Services and innovative display systems such as the BMW Head-Up Display. Throughout this process, the desires of the customer have always taken centre stage. As the first premium automobile manufacturer, BMW makes it possible to book and pay for services flexibly via the BMW ConnectedDrive Store, in the vehicle or on a computer at home. And with the introduction of BMW Connected and the Open Mobility Cloud, BMW is taking the next steps into the future of mobility.

MORE THAN **20** SERVICES AND APPS
IN THE BMW CONNECTED DRIVE STORE.

The ConnectedDrive Services equipment forms the basis for intelligent BMW ConnectedDrive functions, as well as for the integration of selected smartphone apps. This equipment also provides access to the BMW ConnectedDrive Store, in which services and apps can be ordered and extended easily, any time and anywhere to suit the user's individual requirements – for example with the Concierge Service or Online Entertainment, which turn every drive into a convenient and entertaining experience.

IN TOUCH **24/7**
WITH BMW CONNECTED.

What would it be like if you were never late again? What if your BMW already knew your preferred destinations? How would you like reliable navigation, whether you're sitting in your vehicle or not? BMW Connected provides you with the information you want, when and where you want it. BMW Connected is a personal mobility assistant which facilitates your everyday mobility and aids you in reaching your destinations relaxed and on time. With the BMW Connected app, mobility-relevant information such as recommendations for optimal departure times are available at any time via smartphone or smartwatch and can be seamlessly transmitted to the car.

BMW CONNECTED DRIVE SERVICES

The equipment option BMW ConnectedDrive Services¹ forms the basis for the BMW ConnectedDrive functions, which provide the driver with a wide range of information, entertainment and service features while on the road, including news, online search and office functions. In addition, selected smartphone apps can be used and the BMW ConnectedDrive Store can be accessed.

BMW CONNECTED

BMW Connected² is a personal mobility assistant which facilitates everyday mobility and assists drivers in reaching their destinations relaxed and on time. Mobility-relevant information such as recommendations for optimal departure times are available remotely via smartphone or smart watch and can be seamlessly transferred into the car.

**TIME-TO-LEAVE
NOTIFICATION**

BMW Connected² will inform users of recommended departure times via smartphone or smart watch³ to ensure they arrive at their next destination on time. The system calculates recommended departure times based on current vehicle location and real-time traffic data.

ONLINE ENTERTAINMENT

With Online Entertainment^{1,4}, a flat-rate account can be opened with any BMW music partner, such as Napster or Deezer, which can also be used with any other device supported by the provider. That means unlimited access to over 30 million songs.

■ Standard equipment □ Optional equipment



An ideal **axle load distribution of 50:50** helps ensure great directional stability, agile handling and a precise steering response. While at the same time, a lower centre of gravity and shorter overhangs further improve driving characteristics.

The intelligent BMW **xDrive** all-wheel drive system smoothly and variably distributes drive power to the front and rear wheels for maximum traction, driving dynamics and safety in every driving situation. For even better agility, the electronically controlled power distribution for instance counterbalances oversteer or understeer on bends.

The **Variable sport steering**¹ with Servotronic creates a direct and agile steering response and ensures less physical effort is required to turn the wheel. It reacts to the angle of the steering wheel with varying steering ratios. This improves handling when driving more dynamically and reduces the effort needed to steer when parking and turning.

The **8-speed Steptronic transmission**^{2,3} ensures particularly smooth gearshifts and outstanding driving comfort, thanks to fast engine speed transitions and tightly spaced gear ratios. It unites superb comfort with impressive dynamics and increased fuel efficiency.

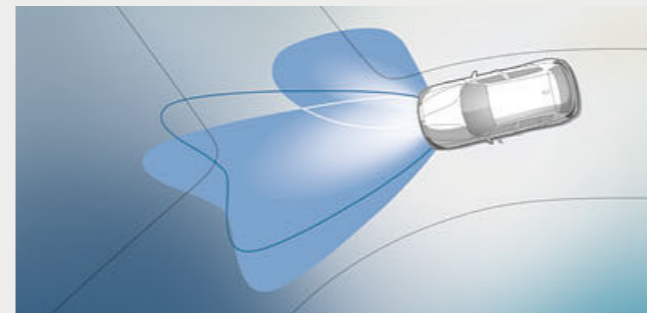

□ **Adaptive LED headlights** with full LED technology include integrated turn indicators, low-beam headlights, high-beam headlights, as well as daytime running lights for safety and optimal illumination of the road. The High-beam assistant and Adaptive headlights with variable light control significantly enhance visibility in the dark – for relaxed driving almost like daily conditions.

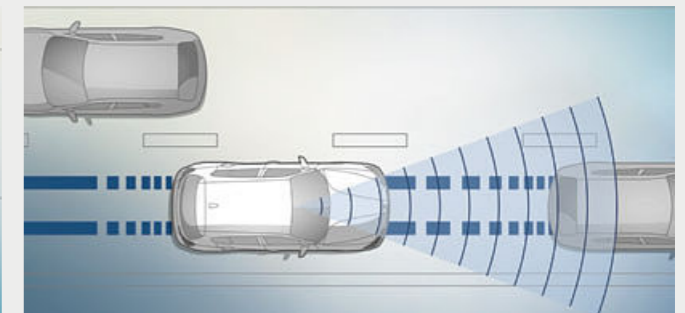

□ **Driving Assistant** combines the Lane Departure Warning and Approach control warning systems. When travelling at speeds between 10 and 60 km/h, the Approach control and person warning with light city braking⁴ function issues a warning if there is a risk of collision with vehicles or pedestrians, and brakes the vehicle in the event of an emergency. At speeds above approx. 70 km/h, the Lane Departure Warning draws the driver's attention to an unintentional lane change by means of slight vibrations of the steering wheel.

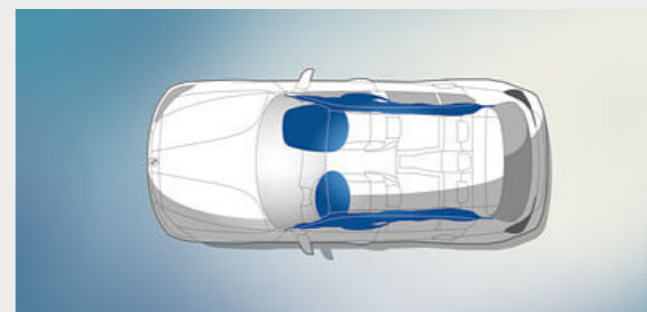

■ **Airbags** for driver and front passenger are part of the optimally coordinated safety components in a BMW. Overall, six airbags provide targeted protection: the driver and front passenger airbags, the head airbags for the entire window surface on the side, and the side airbags integrated into the front seat backrests.

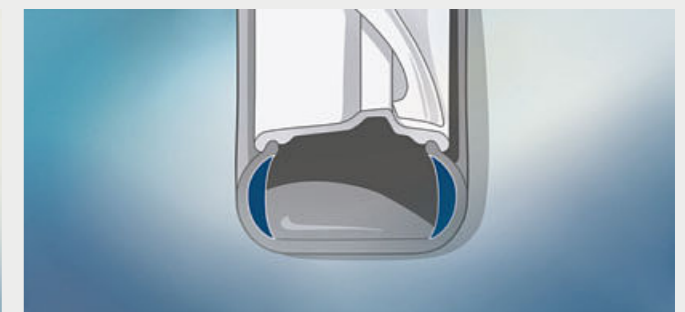

■ **Runflat tyres feature reinforced** side walls. They will not loosen from the rim if the air pressure drops, making it possible to continue driving to the nearest repair shop.

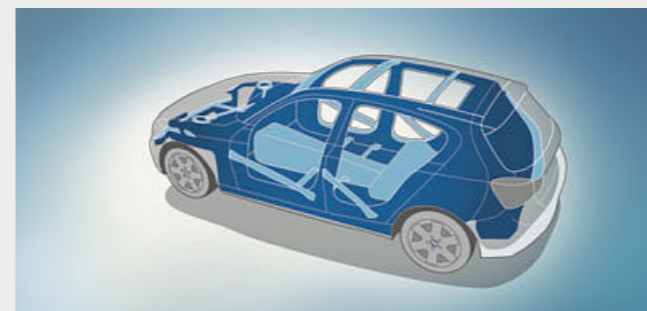

■ The **functional structure** of the Passenger cell is composed of a specialised system of beams and nodal connections, featuring strategically deployed high-strength materials so as to deliver maximum passive safety in the event of front, side and rear collisions.

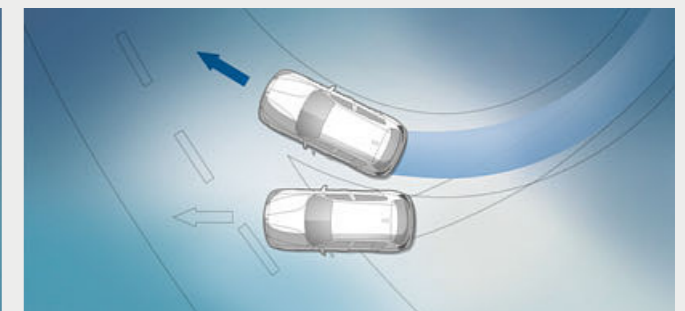

■ The **Dynamic Stability Control (DSC)** with extended functionality stabilises the vehicle as soon as any skidding motion is detected. Its extended functionality includes Cornering Brake Control (CBC), the hill-start and braking assistant, brake drying and braking readiness. For even more athletic driving, the Dynamic Traction Control (DTC) function allows increased wheel slip.

¹ Available as optional equipment.

² Standard for the 125i, 120d xDrive and 125d.

³ Optionally available for the 118i, 120i, 116d, 118d and 120d.

⁴ Function may be limited in the dark or in fog.

Optional and standard equipment vary according to country.

BASE.

Discover more with the new BMW catalogue app. Now available for your smartphone and tablet.



■ The clearly arranged cockpit with leather steering wheel, single-zone Automatic air conditioning and radio Professional are highly impressive even upon first glance.¹

■ The seats in cloth 'Move' Anthracite and the interior trim finishers Satin Silver matt ensure that the interior has a comfortable but sporty feel.

Selected basic equipment features:

- Seats in Cloth 'Move' Anthracite
- Interior trim finishers Satin Silver matt
- Driving Experience Control incl. ECO PRO
- Leather steering wheel
- Automatic air conditioning
- Radio BMW Professional
- 6.5" colour screen and iDrive controller
- Hands-free facility with USB interface
- 16" steel wheel with full-size wheel covers, silver, including BMW emblem



□ 16" light alloy wheels V-spoke style 378, 7J x 16 with 205/55 R16 tyres.

URBAN LINE.

Equipment 24 | 25

■ Standard equipment □ Optional equipment

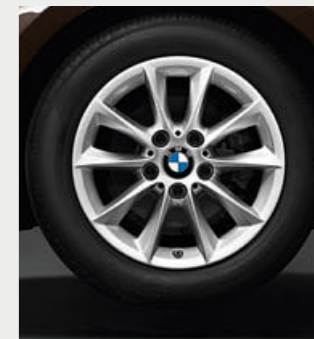

□ The black Sport leather steering wheel with a thick rim and contoured thumb rests has an exceptionally pleasant, high-grip feel.

□ The Sport seats in Leather 'Dakota' Oyster shown here lend the interior of the Urban Line a dynamic look.

□ 17" light alloy wheels Double-spoke style 724 Ferric Grey gloss-lathed, 7.5J x 17 with 225/45 R17 tyres.²

■ 16" light alloy wheels V-spoke style 411, 7J x 16 with 205/55 R16 tyres.

Urban Line exterior equipment:

- BMW kidney grille with nine exclusively designed vertical slats in Oxide Silver, grille frame in Chrome high-gloss
- Front bumper with specific design elements in Oxide Silver matt and Black high-gloss
- 16" light alloy wheels V-spoke style 411, alternatively
- 17" light alloy wheels Double-spoke style 724; other wheels available
- "Urban Line" designation on the side
- Rear bumper with specific design elements in Oxide Silver matt
- Tailpipe trim strip in Chrome matt

Urban Line interior equipment:

- Door sill finishers in Aluminium with "BMW" designation
- Seats in Cloth/leather combination 'Path' Silver/Black, alternatively
- Seats in Leather 'Dakota' Oyster; other upholsteries available
- Sport leather steering wheel
- Car key with Pearl Chrome detailing
- Decorative stitching on the upper portion of the instrument panel
- Interior trim finishers acrylic glass White with structural embossing and accent in Pearl Chrome, alternatively
- Interior trim finishers Fine-wood trim 'Fineline' Stream with accent in Pearl Chrome; other trims available
- Orange or blue variable Ambient light
- B-pillar illumination

² Standard for 125i and 125d.

Optional and standard equipment vary according to country.

¹ Shown here with optional CD drive.

SPORT LINE.

Discover more with the new BMW catalogue app. Now available for your smartphone and tablet.



■ The athletic look of the new BMW 1 Series is intensified by Black high-gloss interior trims with Coral Red matt accent and the Sport leather steering wheel.



□ Sport seats in leather 'Dakota' with Red accent offer optimum lateral support and highlight the dynamic ambience of the interior.



■ 16" light alloy wheels Star-spoke style 376, 7J x 16 with 205/55 R16 tyres.



□ 17" light alloy wheels Star-spoke style 379, Orbit Grey, gloss-lathed, 7.5J x 17 with 225/45 R17 tyres.¹

Sport Line exterior equipment:

- BMW kidney grille with nine exclusively designed vertical slats with front sides in Black high-gloss, grille frame in Chrome high-gloss
- Front bumper with specific design elements in Black high-gloss
- 16" light alloy wheels Star-spoke style 376, alternatively
- 17" light alloy wheels Star-spoke style 379 Bicolour; other wheels available
- "Sport Line" designation on the side
- Mirror caps in Black, alternatively in body colour
- Rear bumper with specific design elements in Black high-gloss
- Tailpipe trim strip in Black Chrome

Sport Line interior equipment:

- Door sill finishers in Aluminium with "BMW" designation
- Sport seats in Cloth 'Corner' Anthracite with Red accent, alternatively
- Sport seats in Leather 'Dakota' Black with Red accent; additional upholstery available
- Sport leather steering wheel with red contrast stitching
- Armrest front, sliding
- Car key with Red detailing
- Instrument cluster with speedometer and revolution counter with chronoscaling
- Decorative stitching on the upper portion of the instrument panel
- Interior trim finishers black high-gloss with accent in Coral Red matt, alternatively
- Interior trim finishers Aluminium, finely brushed lengthwise with accent in Black high-gloss; other trims available
- Orange or white variable Ambient light
- Driving Experience Control with additional SPORT+ mode

EDITION SPORT LINE SHADOW.

Equipment 26 | 27

■ Standard equipment □ Optional equipment



□ The new BMW 1 Series with the Edition Sport Shadow Line in the optional exterior colour Melbourne Red metallic, with dark LED headlights, high-gloss black kidney grille frame and 17" light alloy wheels 725 Orbit Grey, gloss-lathed.



■ 17" light alloy wheels Double-spoke style 725 Orbit Grey gloss-lathed, 7.5J x 17 with 225/45 R17 tyres.

The Edition Sport Line Shadow equipment features:

- BMW kidney grille with nine exclusively designed vertical slats in Black high-gloss and wide design, grille frame in black high-gloss
- Dark front and rear lights with LED technology
- 17" M light alloy wheels Double-spoke style 725, other wheels available
- BMW Individual high-gloss Shadow Line
- Headliner anthracite
- Tailpipe trim strip in Black Chrome

The Edition Sport Line Shadow includes the following Sport Line exterior equipment:

- Front bumper with specific design elements in Black high-gloss
- LED headlights
- LED fog lights
- 16" light alloy wheels Star-spoke style 376, alternatively
- 17" light alloy wheels Star-spoke style 379 Bicolour; other wheels available
- "Sport Line" designation on the side
- Mirror caps in Black, alternatively in body colour
- Rear bumper with specific design elements in Black high-gloss
- Tailpipe trim strip in Black Chrome

The Edition Sport Line Shadow includes the following Sport Line interior equipment:

- Door sill finishers in Aluminium with "BMW" designation
- Sport seats in Cloth 'Corner' Anthracite with Red accent, alternatively
- Sport seats in Leather 'Dakota' Black with Red accent; additional upholstery available
- Sport leather steering wheel with Red contrast stitching
- Instrument cluster with speedometer and revolution counter with chronoscaling and Red accent
- Interior trim finishers Black high-gloss with accent in Coral Red matt, alternatively
- Interior trim finishers Aluminium, finely brushed lengthwise with accent in Black high-gloss; other trims available
- Orange or white variable Ambient light
- Lights package
- Driving Experience Control with additional SPORT+ mode
- Car key with Red detailing

¹ Standard for 125i and 125d.

Optional and standard equipment vary according to country.

M SPORT PACKAGE.

Discover more with the new BMW catalogue app. Now available for your smartphone and tablet.

powered by 



■ In combination with the interior trim finishers Aluminium Hexagon with highlight trim finishers Blue matt, the M leather steering wheel also accentuates the sporty yet elegant tone of the interior.



□ 18" M light alloy wheels Double-spoke style 461 M Ferric Grey metallic, front 7.5 J x 18 with 225/40 R 18 tyres, rear 8 J x 18 with 245/35 R 18 tyres.



□ The 8-speed Steptronic Sport transmission offers incredibly sporty gear changes. Whether automatic or manual using gearshift paddles or gear lever.

M Sport package exterior equipment:

- M Aerodynamics package with front apron, side skirts and rear apron with diffuser insert in Dark Shadow metallic
- BMW kidney grille with nine exclusively designed vertical slats with front sides in Black high-gloss, grille frame in Chrome high-gloss
- Fog lights
- 17" M light alloy wheels Double-spoke style 460 M with mixed tyres, or alternatively
- 18" M light alloy wheels Double-spoke style 719 M Jet Black; other wheels available
- M Sport suspension, alternatively Standard running gear or
- Adaptive M suspension
- BMW Individual high-gloss Shadow Line
- M designation on the sides
- Tailpipe trim strip in Chrome high-gloss
- Exclusive paintwork in Estoril Blue metallic; other paintworks available

M Sport package interior equipment:

- M door sill finishers, M driver footrest, knee pad on the right of the driver's footwell
- Sport seats for driver and front passenger in Cloth/Alcantara combination 'Hexagon' Anthracite in exclusive M look, alternatively
- Sport seats for driver and front passenger in Leather 'Dakota' Oyster; other upholsteries available
- M Leather steering wheel
- Armrest front, sliding
- BMW Individual headliner anthracite
- Instrument cluster with speedometer and revolution counter with chronoscaling
- Decorative stitching on the upper portion of the instrument panel
- Interior trim finishers in Aluminium Hexagon with Blue matt accent, alternatively Interior trim finishers in Aluminium, finely brushed lengthwise with Black high-gloss accent; other trims available
- Shortened gear lever with M designation¹
- Driving Experience Control with additional SPORT+ mode
- Orange or white variable Ambient light
- Car key with Estoril Blue detailing

EDITION M SPORT SHADOW.

Equipment 28 | 29

■ Standard equipment □ Optional equipment



■ The dark front lights with LED technology give the exterior an athletic edge.



□ 18" M light alloy wheels Double-spoke style 719 M Bicolour Jet Black with mixed tyres, front 7.5J x 18 with 225/40 R18 tyres, rear 8J x 18 with 245/35 R18 tyres.



■ 18" M light alloy wheels Double-spoke style 719 M Jet Black with mixed tyres, front 7.5J x 18 with 225/40 R18 tyres, rear 8J x 18 with 245/35 R18 tyres.

The Edition M Sport Shadow equipment features:

- BMW kidney grille with nine exclusively designed vertical slats in Black high-gloss with wide design, grille frame in Black high-gloss
- Dark front and rear lights with LED technology
- 18" M light alloy wheels Double-spoke style 719 M Jet Black; other wheels available
- Tailpipe trim strip in Black Chrome

The Edition M Sport Shadow includes the following M Sport package exterior equipment:

- M Aerodynamics package with front apron, side skirts and rear apron with diffuser insert in Dark Shadow metallic
- LED headlights
- LED fog lights
- M Sport suspension, alternatively Standard running gear or
- Adaptive M suspension
- BMW Individual high-gloss Shadow Line
- M logo on the sides
- Exterior mirror caps in body colour
- Exclusive paintwork in Estoril Blue metallic; other paintworks available

The Edition M Sport Shadow includes the following M Sport package interior equipment:

- M door sill finishers, M driver footrest, knee pad on the right of the driver's footwell
- Sport seats for driver and front passenger in cloth/Alcantara combination 'Hexagon', Anthracite in exclusive M style; other upholstery options available
- M Leather steering wheel with multifunction buttons
- BMW Individual headliner anthracite
- Instrument cluster with speedometer and revolution counter with chronoscaling
- Decorative stitching on the upper portion of the instrument panel
- Interior trim finishers in Aluminium Hexagon with Blue matt accent, alternatively Interior trim finishers in Aluminium, finely brushed lengthwise with Black high-gloss accent; other trims available
- Shortened gear lever with M designation¹
- Driving Experience Control with additional SPORT+ mode
- Orange or white variable Ambient light
- Lights package
- Car key with Estoril Blue detailing

¹ Short gear lever only available in conjunction with manual transmission.

Optional and standard equipment vary according to country.

BMW M PERFORMANCE.

The new BMW M140i Edition Shadow.

The M Performance TwinPower Turbo inline 6-cylinder petrol engine features superior power delivery, silky smooth running and an exceptional performance. Not only that, but the brawny 3.0-litre engine emits a captivatingly sporty sound as it goes about its work, thanks to a sound-optimised exhaust system with an innovative flap concept. This engine combines the Valvetronic fully variable valve control including Double-VANOS, High-Precision Injection and a TwinScroll turbocharger to optimally fill the cylinders. The result: a top performance of 250 kW (340 hp) and a maximum torque of 500 Nm. This means that the Turbo petrol engine accelerates the car from 0 to 100 km/h in a breathtaking 4.8 s, reaching a top speed of 250 km/h. Thanks to various intelligent technological innovations, its fuel consumption drops to a combined rate of just 7.8 litres per 100 km at a CO₂ emissions level of only 179 g/km. Impressively efficient, packed with power and delivering a direct response even at low engine speeds – this all-conquering drive train is destined to delight the driver of every M Performance vehicle.

The new BMW M140i with Edition Shadow in the optional exterior paintwork Black Sapphire metallic with dark LED headlights and rear lights, black kidney grille frame and optional 18" M light alloy wheels Double-spoke style 719 M Bicolour Jet Black.

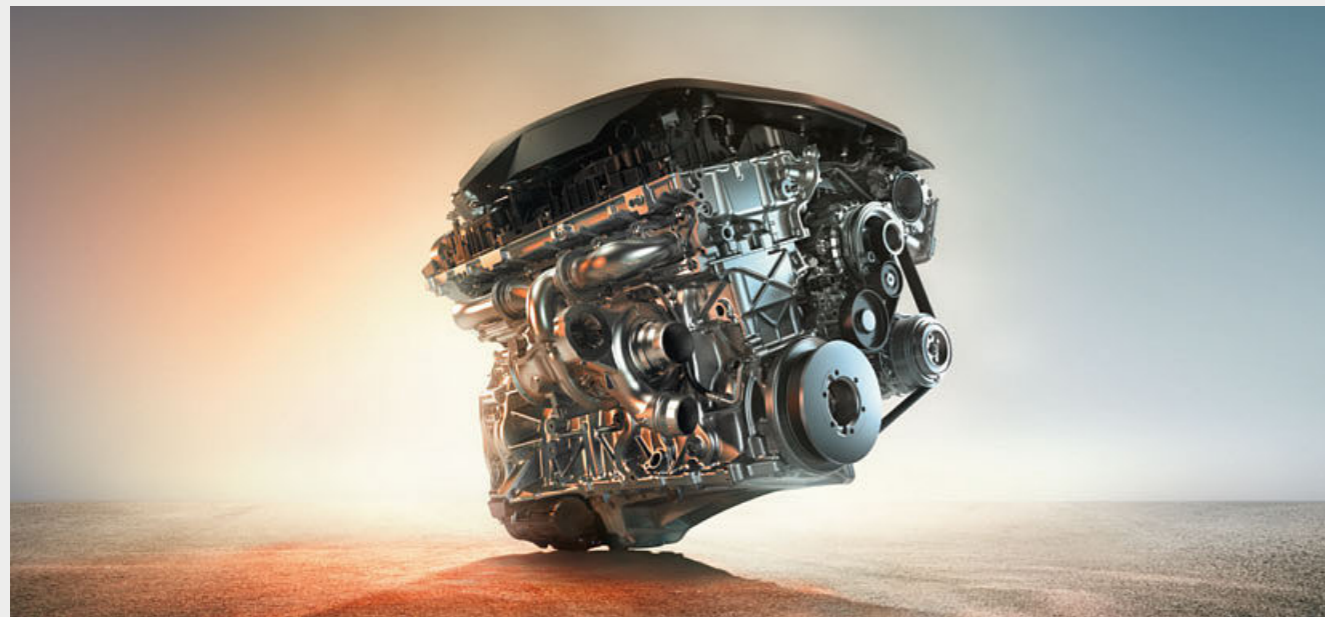

The M leather steering wheel with interior trim finishers Aluminium Hexagon with highlight trim finishers Black high-gloss creates a dynamic look in the interior.



The mirror caps for the M Performance automobile come in Ferric Grey.

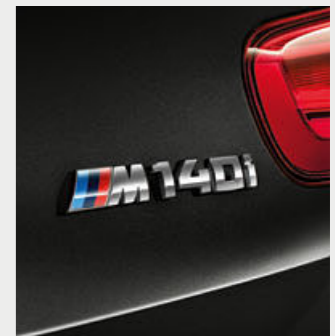

An impressive emblem: the M140i designation on the rear.

EQUIPMENT HIGHLIGHTS.

Discover more with the new BMW catalogue app. Now available for your smartphone and tablet.

■ Standard equipment □ Optional equipment



□ Adaptive LED headlights with full LED technology include integrated turn indicators, low-beam headlights, high-beam headlights, as well as daytime running lights for safety and optimal illumination of the road. The High-beam assistant and Adaptive headlights with variable light control significantly enhance visibility in the dark – for relaxed driving almost like daily conditions.



□ The electrical glass roof with slide and lift function including sun protection, anti-trap protection, comfort opening and closing via remote control and one-touch function brings light into the interior and allows passengers to regulate the air flow rate according to their preference to create a pleasant interior climate. The integrated, automatically extending wind deflector guarantees a high level of acoustic comfort.



■ The two-part Rear lights with the characteristic L-shaped design are based on LED technology. They each have a lighting element in the body as well as in the tailgate part of the light. Should the vehicle brake hard, the drivers of cars behind are warned in a very conspicuous manner by the dynamic brake light function with flashing brake lights.



□ The Comfort access system allows passengers to enter the car via the front doors and open the tailgate without having to actively use the key.



□ Interior and driver-side exterior mirrors with automatic anti-dazzle function, including fold-in function for the exterior mirrors and automatic parking function for the front passenger exterior mirror.

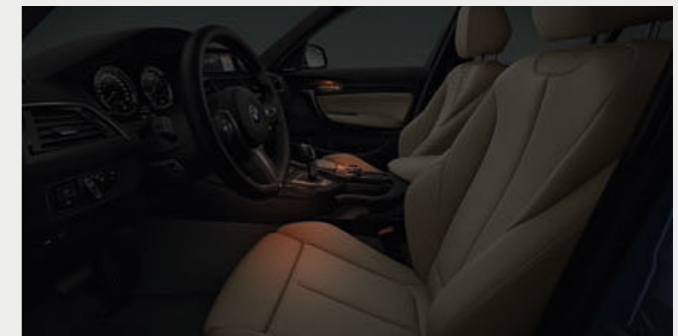

□ The Lights package creates an atmospheric ambience in the interior. It includes a variety of additional LED lights: front and rear reading lights, vanity mirror lights for driver and front passenger, front footwell lights, Ambient light in the front and rear, illuminated door grip shells, as well as exit lights in the doors and vicinity lighting in the exterior door handles.



□ The M Sport brake has four-piston fixed callipers at the front and two-piston floating callipers at the rear in blue with the M designation and features large brake discs to ensure an outstanding braking performance.



□ When not in use, the removable ball head of the trailer tow hitch has no negative impact on the sporty appearance of the rear. The equipment, which allows a bike rack to be mounted, features trailer stability control, as well as activation of the trailer light functions. The maximum trailer load is 1,500 kg, depending on the engine fitted.¹



□ The 8-speed Steptronic transmission ensures particularly smooth gearshifts and outstanding driving comfort, thanks to fast engine speed transitions and tightly spaced gear ratios. It unites superb comfort with impressive dynamics and increased fuel efficiency.



□ The Through-loading system includes rear seat backrests that can be flexibly divided in a 40:20:40 ratio. For example, two passengers can be seated comfortably in the rear, while long objects such as ski and snowboard bags can be transported at the same time. The centre armrest features two cupholders.

¹ The actual total weight of the trailer must not exceed the maximum trailer load, taking into account the maximum tow bar download.

EQUIPMENT HIGHLIGHTS.

Discover more with the new BMW catalogue app. Now available for your smartphone and tablet.

■ Standard equipment □ Optional equipment



□ The Navigation system Professional, including hands-free facility, USB interface, 8.8" LCD colour display and Radio BMW Professional with a DVD player, comes with a three-dimensional map display and 20 GB of memory. The system is operated intuitively via the iDrive Touch Controller. Automatic map updates are available for three years without license fees.¹



□ Navigation system Business with iDrive Controller comes with a built-in 6.5" LCD colour display. Route guidance is provided via an arrow or map display, as well as verbally. The navigation system is operated intuitively via the iDrive Controller with direct menu control buttons and functional bookmarks or via voice control. Map updates are available for three years without license fees.¹



□ The Remote Services⁵ offered by the BMW Connected App allows various functions of the vehicle, such as locking and unlocking the car or displaying the car location, to be operated remotely. To use this feature, customers simply need to activate Remote Services once in the BMW ConnectedDrive customer portal at www.bmw-connecteddrive.com.



□ Active cruise control with Stop&Go function⁶ maintains a preselected speed, as well as the distance to the driver ahead.
□ The Steering-wheel heating quickly warms up the rim of the steering wheel at the push of a button – which is especially comfortable in winter.



□ Automatic air conditioning with two-zone control includes Automatic Air Recirculation (AAR) with an active carbon filter, as well as fogging sensors and solar sensors.

□ The Seat heating for driver and front passenger heats the seat surface and middle section of the backrest to one of three levels as desired.



□ Speed Limit Info² including No-overtaking indicator detects current speed limits and no-overtaking zones and shows them on the Info Display in the instrument cluster and on the BMW Head-Up Display.



□ The Multifunction buttons for the steering wheel can be used to operate the telephone, voice control and audio functions, as well as the Manual Speed Limiter.

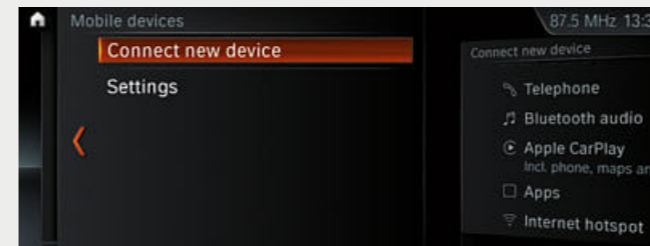

□ The equipment includes a built-in WiFi hotspot⁷ using the LTE standard, which allows for a paid internet connection. The vehicle is connected via the built-in SIM card with a fee-based hotspot plan from a service provider.

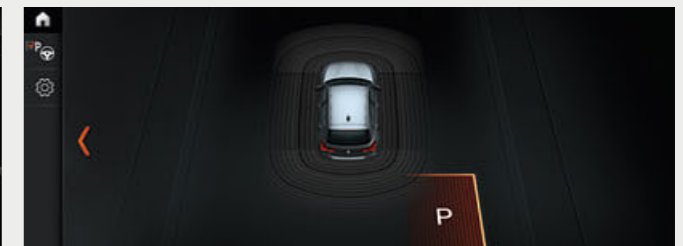

□ The Parking assistant makes parking parallel and perpendicular to the road easier. The system works by measuring even tight potential parallel parking spaces while driving past at a low speed. When a suitable space has been found, the Parking assistant takes over the steering, while the driver is responsible for selecting the correct gear, as well as pressing the accelerator and brakes.



□ Telephony with wireless charging³ includes a wireless charging dock and additional USB ports. A roof aerial with aerial amplifier ensures optimum mobile reception. Two mobile telephones and an audio player can be connected simultaneously via Bluetooth. Also included are: Bluetooth Office, an NFC interface and the technical capacity for a WiFi hotspot.

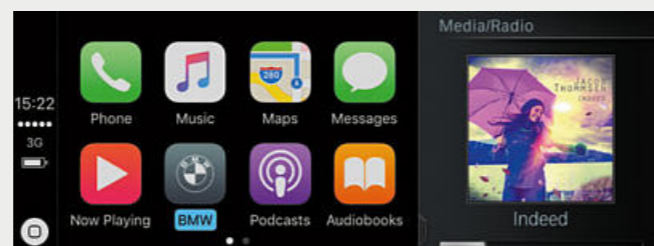

□ Preparation for Apple CarPlay^{2,4} supports the convenient and wireless use of selected iPhone[®] functions in the vehicle. This allows smartphone content and functions such as music, iMessages/text messages, telephony, Siri, navigation and selected third-party apps to be displayed and operated via the vehicle's user interface and via Voice control.



□ Driving Assistant combines the Lane Departure Warning and Approach control warning systems. When travelling at speeds between 10 and 60 km/h, the Approach control and person warning with light city braking function⁸ issues a warning if there is a risk of collision with vehicles or pedestrians, and brakes the vehicle in the event of an emergency. At speeds above approx. 70 km/h, the Lane Departure Warning draws the driver's attention to an unintentional lane change by means of slight vibrations of the steering wheel.

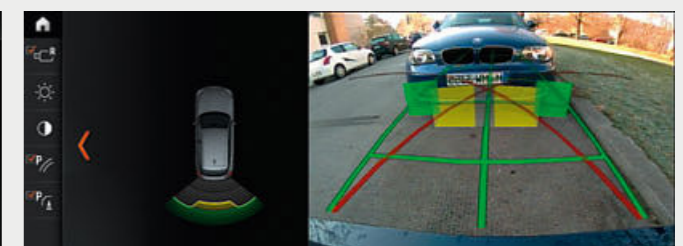

□ The Rear view camera enables improved orientation when reversing at speeds below 15 km/h, for example when parking. It shows the area behind the car on the Control Display. Interactive track lines for measuring distance and turning circles assist the driver when manoeuvring, obstacles are marked in colour.

¹ As part of BMW ConnectedDrive, in selected European countries the system automatically updates domestic maps up to four times per year, for a period of three years.
² Only available in conjunction with a navigation system.

³ Supports inductive charging for Qi-compatible mobile phones. Special charging cases are available from Original BMW Accessories for selected smartphones that do not support the Qi standard for inductive charging.

⁴ The compatibility and range of functions from Apple CarPlay[®] depend on the model year and the software installed on the iPhone[®]. When the Apple CarPlay[®] preparation is used, selected vehicle data is transferred to the phone. The mobile phone manufacturer is responsible for further data processing.
⁵ The Internet option is only available in conjunction with ConnectedDrive Services.

⁶ Not available for the 116i, M140i, M140i xDrive, 114d or 118d xDrive.
⁷ The WiFi hotspot fulfils all in-vehicle requirements for use of the internet with the maximum LTE standard. Usage is subject to cost.
⁸ Function may be limited in darkness or in fog.

Optional and standard equipment vary according to country.

EXTERIOR COLOURS.

Discover more with the new BMW catalogue app. Now available for your smartphone and tablet.

■ Standard equipment □ Optional equipment



■ **Non-metallic** 668 Black



■ **Non-metallic** 300 Alpine White

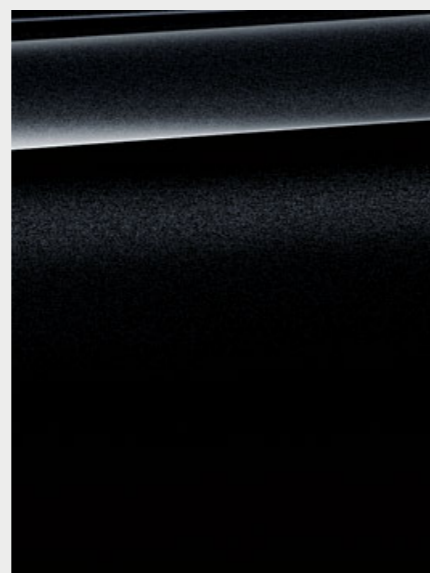

□ **Metallic** 475 Black Sapphire¹



□ **Metallic** A96 Mineral White



□ **Metallic** A83 Glacier Silver

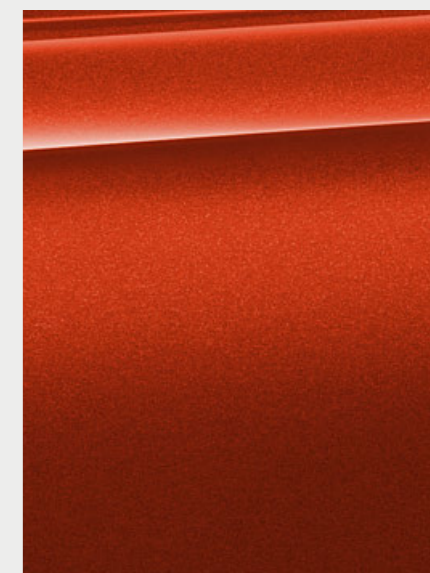

□ **Metallic** C1X Sunset Orange¹

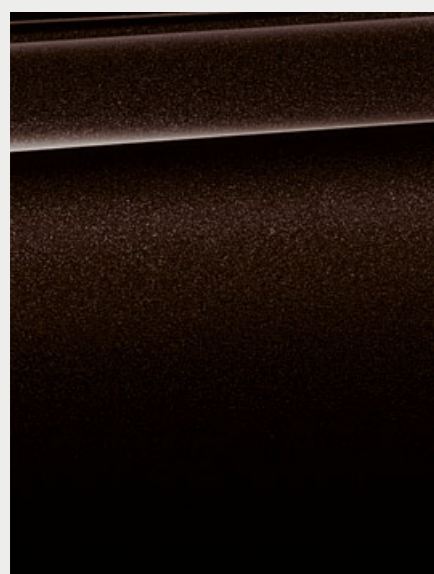

□ **Metallic** B53 Sparkling Brown



□ **Metallic** C10 Mediterranean Blue

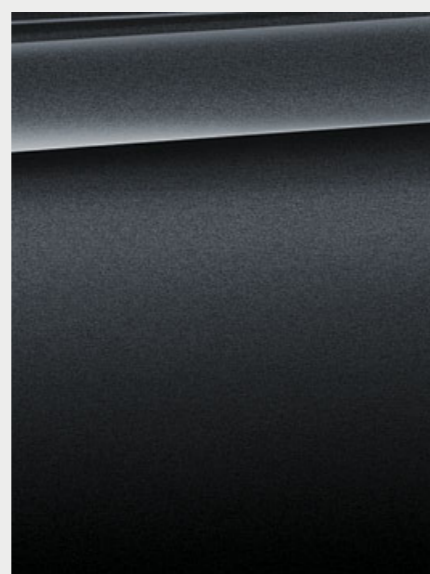

□ **Metallic** B39 Mineral Grey¹

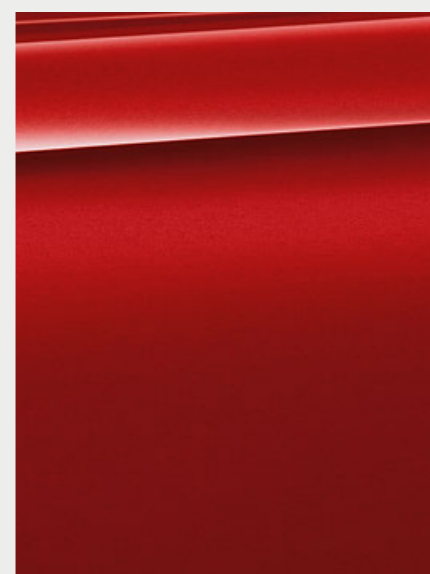

□ **Metallic** A75 Melbourne Red¹

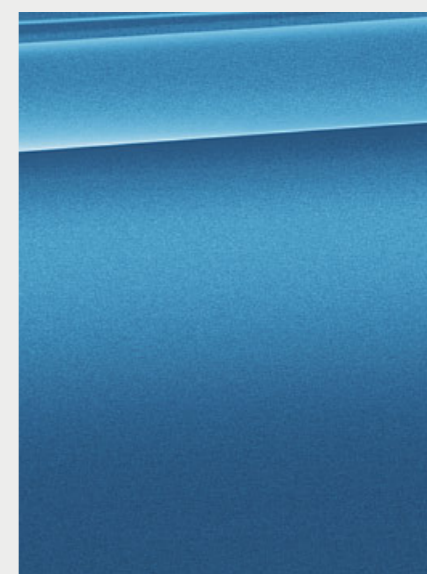

□ **Metallic** C1R Seaside Blue

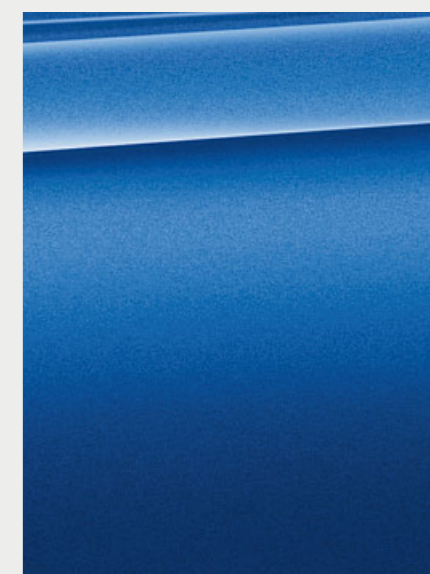

□ **Metallic** B45 Estoril Blue¹

M SPORT PACKAGE

[Colours] The colours printed above are intended to provide you with a first impression of paints and materials available for your BMW. Experience has shown, however, that printed images of paint, upholstery and interior trim colours cannot faithfully reproduce

the actual appearance of the originals. We recommend therefore that you consult your BMW partner who will be able to show you original samples and assist with special requests.

¹ Optionally available for the M Sport package.

Optional and standard equipment vary according to country.

INTERIOR COLOURS.

Discover more with the new BMW catalogue app. Now available for your smartphone and tablet.

■ Standard equipment □ Optional equipment

CLOTH

Available with

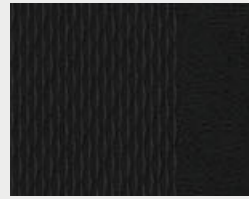

■ Base

Move cloth
BDAT Anthracite¹



□ Base
■ Urban Line
■ Sport Line

Corner cloth
CCL1 Anthracite
with Grey highlights

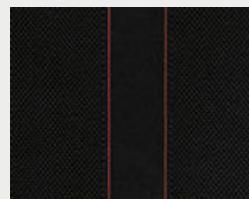

■ Sport Line

Corner cloth
CCL2 Anthracite
with Red highlights²

CLOTH/LEATHER COMBINATION

Available with



□ Base
■ Urban Line

Cloth/leather combination ,Path'
CPH6 Silver/Black¹



■ Urban Line

Cloth/leather combination ,Path'
CPLJ Silver/Pearl
Grey¹

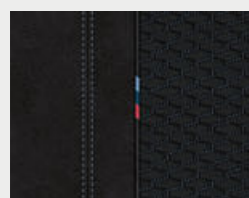

■ M Sport package

**Hexagon cloth/
Alcantara
upholstery**
HAAT Anthracite

LEATHER

Available with



□ Base
□ Urban Line
□ Sport Line
□ M Sport package

Dakota leather
LCCX Oyster



□ Sport Line

Dakota leather
LCL3 Black with
Red highlights

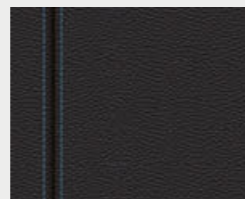

□ M Sport package

Dakota leather
LCNL Black with
contrast stitching
in Blue

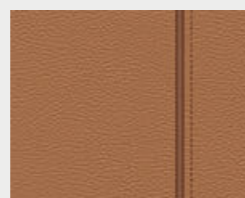

□ Base
□ Urban Line
□ Sport Line
□ M Sport package

Dakota leather
LCRY Cognac with
Brown highlights



□ Base
□ Urban Line
□ Sport Line
□ M Sport package

Dakota leather
LCSW Black

INTERIOR TRIM FINISHERS

Available with



■ Base

4CG Satin Silver
matt



□ Base
■ Sport Line
■ M Sport package

4LU Black high-
gloss with Pearl
Chrome highlights

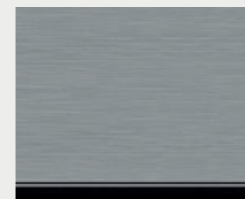

□ Base
□ Urban Line
□ Sport Line
■ M Sport package

4FT Aluminium,
finely brushed
lengthwise with
highlight trim finisher
Black high-gloss



□ Base
□ Urban Line
□ Sport Line
□ M Sport package

4LR Fine-wood trim
Fineline Stream,
highlight trim finishers
Pearl Chrome



□ Base
□ Urban Line
□ Sport Line
■ M Sport package

4LS Aluminium,
finely brushed
lengthwise, highlight
trim finishers Pearl
Chrome

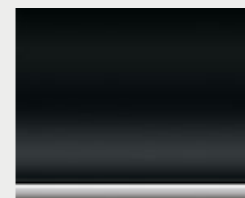

■ Urban Line

4KX Acrylic glass
Black with highlight
trim finishers Pearl
Chrome

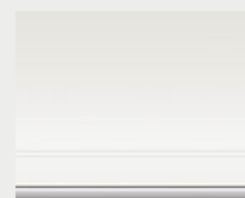

■ Urban Line

4KY Acrylic glass
White with structural
embossing and
highlight trim finishers
Pearl Chrome

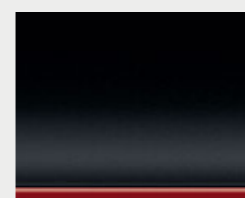

■ Sport Line

4LV Black high-
gloss with highlight
trim finisher Coral
Red matt

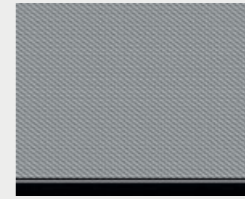

■ M Sport package

4WG Aluminium
Hexagon with
highlight trim
finishers Black
high-gloss

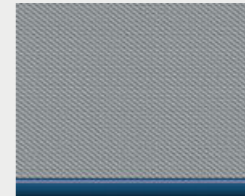

■ M Sport package

4WF Aluminium
Hexagon with
highlight trim finisher
Blue matt

INTERIOR COLOURS

Available with

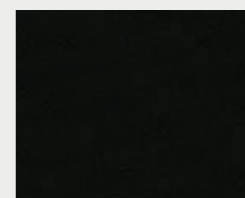

Base
Urban Line
Sport Line
M Sport package

Black

BMW INDIVIDUAL HEADLINER

Available with

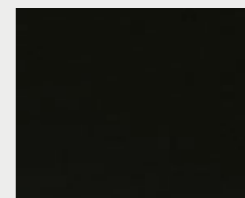

□ Base
□ Urban Line
□ Sport Line
■ M Sport package

**BMW Individual
headliner**
775 Anthracite

¹ Please note that even normal long- or short-term use can lead to unrecoverable upholstery damage. This can be caused in particular by non-colourfast clothing.

² Only available in conjunction with standard seats.

³ Only available in conjunction with sports seats.

Optional and standard equipment vary according to country. Please note that the interior colour depends on the selected upholstery colour.

WHEELS AND TYRES.

Discover more with the new BMW catalogue app. Now available for your smartphone and tablet.



□ 17" light alloy wheels Double-spoke style 655, 7.5J x 17, 225/45 R17 tyres.



□ 16" light alloy wheels turbine styling 406, BMW EfficientDynamics, aerodynamically optimised, Orbit Grey, gloss-lathed, 7J x 16, 205/55 R16 tyres.



□ 17" light alloy wheels Y-spoke style 380, 7J x 17 with 205/50 R17 tyres.



□ 18" light alloy wheels Double-spoke style 385 with mixed tyres, front 7.5J x 18 with 225/40 R18 tyres, rear 8J x 18 with 245/35 R18 tyres.



□ 16" light alloy wheels Star-spoke style 654, 7J x 16 with 205/55 R16 tyres.



□ 17" M light alloy wheels Double-spoke style 460 M with mixed tyres, front 7.5J x 17 with 225/45 R17 tyres, rear 8J x 17 with 245/40 R17 tyres.¹



□ 18" M light alloy wheels Double-spoke style 719 M Bicolour Jet Black with mixed tyres, front 7.5J x 18 with 225/40 R18 tyres, rear 8J x 18 with 245/35 R18 tyres.¹



□ 18" M light alloy wheels Double-spoke style 436 M with mixed tyres, front 7.5J x 18 with 225/40 R18 tyres, rear 8J x 18 with 245/35 R18 tyres.²



□ 18" M light alloy wheels Double-spoke style 436 M Orbit Grey metallic with mixed tyres, front 7.5J x 18 with 225/40 R18 tyres, rear 8J x 18 with 245/35 R18 tyres.³

ORIGINAL BMW ACCESSORIES.

Equipment 40 | 41

■ Standard equipment □ Optional equipment ○ Accessories



Roof box 320 for up to five pairs of skis, compatible with all BMW roof rack systems. Can be opened from both sides and has triple central locking on each side.

19" light alloy wheels Double-spoke style 624 M in bi-colour matt Black, gloss-lathed on the visible side with M badge. TPMS complete summer wheel set with mixed-size run-flat tyres, wheel size 7.5J x 19 with tyre size 225/35 R19 88Y XL at the front and 8J x 19 with tyre size 245/35 R19 88Y XL at the rear.



○ Lightweight, sturdy rear bike rack for two bikes/e-bikes (can be extended to accommodate three bikes). Carries up to 60 kg and can be folded up compactly.



○ The BMW Head-Up Screen puts vehicle and navigation information into the driver's line of sight – in combination with a smartphone interface.

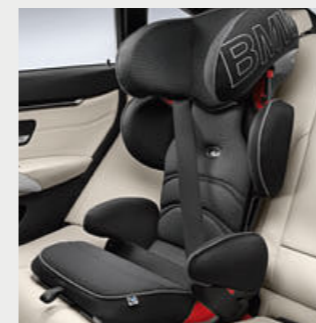

○ Adjustable seat for children aged approx. 3 to 12 years (approx. 15–36 kg). With patented air pads for increased protection against impact and ISOFIX connectors.



○ Secure base for the Apple iPad® 2, 3 or 4. The holder is snapped into the basic carrier and can be rotated 360° as well as tilted to the desired angle.



○ Anti-slip, water-resistant, durable mat for protecting the luggage compartment from dirt and moisture. In black/light grey; colouring complements the interior.



○ Precisely fitted protection against moisture and dirt, keep feet from getting wet in the footwell. The black/light grey design perfectly complements the interior.

¹ Only available in conjunction with the M Sport package.
² Only available for M140i and M140i xDrive.
³ Only available with the Edition Shadow.

Optional and standard equipment vary according to country.

Discover the wide range of innovative solutions available for the exterior, interior, communication and information as well as transportation and luggage compartment solutions. Your BMW Partner is on hand to advise you on the whole range of Original

BMW Accessories and can also provide you with a special accessories catalogue. For more information visit www.bmw.com/accessories

BMW 1 SERIES 3-DOOR AND 5-DOOR		116i	118i	120i	125i	M140i M140i xDrive	114d	116d	118d 118d xDrive	120d 120d xDrive	125d
Weight/capacity											
Unladen weight EU ¹ BMW 1 Series 3-door	kg	1375	1375 [1390]	1440 [1450]	[1475]	1520 [1545]	1395	1395 [1425]	1425 [1450]	1445 [1460]	[1500]
Unladen weight EU ¹ BMW 1 Series 5-door	kg	1380	1380 [1395]	1445 [1455]	[1475]	1525 [1550]	1395	1395 [1425]	1425 [1450]	1450 [1465]	[1505]
Unladen weight EU ¹ BMW 1 Series 3-door/1 Series 5-door (xDrive)	kg	-	-	-	-	[1615/1615]	-	-	1495/1505	[1525/1530]	-
Maximum permissible weight BMW 1 Series 3-door	kg	1865	1865 [1880]	1930 [1940]	[1965]	2010 [2035]	1885	1885 [1915]	1915 [1940]	1935 [1950]	[1990]
Maximum permissible weight BMW 1 Series 5-door	kg	1870	1870 [1885]	1935 [1945]	[1965]	2015 [2040]	1885	1885 [1915]	1915 [1940]	1940 [1955]	[1995]
Maximum permissible weight BMW 1 Series 3-door/5-door (xDrive)	kg	-	-	-	-	[2090/2090]	-	-	1970/1980	[2000/2005]	-
Permitted load	kg	565	565 [565]	565 [565]	[565]	565 [565]	565	565 [565]	565 [565]	565 [565]	[565]
Permitted load (xDrive)	kg	-	-	-	-	[550]	-	-	550	[550]	-
Permitted trailer load, unbraked ²	kg	650	650 [650]	670 [670]	[680]	-	-	690 [690]	690 [690]	710 [710]	[710] ⁹
Permitted trailer load, unbraked (xDrive)	kg	-	-	-	-	-	-	-	710	[750]	-
Permitted trailer load, braked, max. 12% gradient ² / 8% gradient ²	kg	1200/1200	1300/1300 [1300/1300]	1500/1500 [1500/1500]	[1500/1500]	-	-	1500/1500 [1500/1500]	1500/1500 [1500/1500]	1500/1500 [1500/1500]	[1500/1500]
Permitted trailer load, braked, max. 12% gradient ² / 8% gradient ² (xDrive)	kg	-	-	-	-	-	-	-	1500/1500	[1500/1500]	-
Luggage compartment capacity	l	360-1200	360-1200	360-1200	360-1200	360-1200	360-1200	360-1200	360-1200	360-1200	360-1200
Engine^{3,4}											
Cylinders/valves		3/4	3/4	4/4	4/4	6/4	3/4	3/4	4/4	4/4	4/4
Capacity	cc	1499	1499	1998	1998	2998	1496	1496	1995	1995	1995
Max. output/engine speed	kW/1/min	80(109)/4250	100(136)/4400	135(184)/5000	165(224)/5200-6500	250(340)/5500	70(95)/4000	85(116)/4000	110(150)/4000	140(190)/4000	165(224)/4400
Max. torque/ engine speed	Nm/rpm	180/1250-4250	220/1250-4300	290 [270]/1350-4250 ⁵	310/1400-5000	500/1520-4500	235/1750-2250	270/1750-2250	320/1500-3000	400/1750-2500	450/1500-3000
Power transmission											
Drive configuration		Rear-wheel	Rear-wheel	Rear-wheel	Rear-wheel	Rear-wheel/all-wheel	Rear-wheel	Rear-wheel	Rear-wheel/all-wheel	Rear-wheel/all-wheel	Rear-wheel
Standard transmission		6-speed manual	6-speed manual	6-speed manual	8-speed Steptronic	6-speed manual	6-speed manual	6-speed manual	6-speed manual	6-speed manual	8-speed Steptronic
Standard transmission (xDrive)		-	-	-	-	8-speed Steptronic Sport	-	-	6-speed manual	8-speed Steptronic	-
Performance											
Top speed	km/h	195	210 [210]	230 [225]	[243]	250 ⁶ [250] ⁶	185	200 [200]	212 [212]	228 [228]	[240]
Top speed (xDrive)	km/h	-	-	-	-	[250] ⁶	-	-	210	[222]	-
Acceleration 0-100 km/h	s	10.9	8.5 [8.7]	7.1 [7.1]	[6.1]	4.8 [4.6]	12.2	10.3 [10.3]	8.3 [8.1]	7.1 [7.0]	[6.3]
Acceleration (xDrive) 0-100 km/h	s	-	-	-	-	[4.4]	-	-	8.4	[6.8]	-
Fuel consumption^{3,4}											
Urban	l/100 km	6.3-6.8	6.2-6.7 [5.9-6.4]	7.6-8.1 [7.0-7.4]	[7.2-7.4]	10.6 [9.4]	3.9-4.4	4.3-4.8 [4.1-4.6]	4.8-5.2 [4.5-4.9]	5.0-5.5 [4.6-5.1]	[5.1-5.4]
Urban (xDrive)	l/100 km	-	-	-	-	[9.8]	-	-	5.1-5.6	[5.1-5.5]	-
Extra-urban	l/100 km	4.2-4.6	4.3-4.7 [4.2-4.6]	4.7-5.0 [4.7-5.0]	[4.9-5.0]	6.2 [5.8]	3.4-3.8	3.3-3.7 [3.4-3.8]	3.5-3.8 [3.4-3.8]	3.6-3.9 [3.5-3.9]	[3.9-4.1]
Extra-urban (xDrive)	l/100 km	-	-	-	-	6.0	-	-	3.8-4.1	[3.9-4.3]	-
Combined	l/100 km	5.0-5.4	5.0-5.4 [4.8-5.2]	5.7-6.1 [5.5-5.9]	[5.7-5.9]	7.8 [7.1]	3.6-4.0	3.7-4.1 [3.6-4.1]	4.0-4.3 [3.8-4.2]	4.1-4.5 [3.9-4.3]	[4.3-4.6]
Combined (xDrive)	l/100 km	-	-	-	-	[7.4]	-	-	4.3-4.7	[4.3-4.7]	-
CO ₂ emissions, combined	g/km	116-126	116-126 [112-122]	131-140 [126-135]	[130-134]	179 [163]	95-106	97-107 [96-107]	104-114 [99-110]	108-118 [103-114]	[114-121]
CO ₂ emissions, combined (xDrive)	g/km	-	-	-	-	[169]	-	-	113-123	[113-124]	-
Tank capacity (approx.)	l	52	52	52	52	52	52	52	52	52	52
Wheels/tyres											
Tyre dimensions		195/55 R 16 H	195/55 R 16 H	195/55 R 16 W	205/50 R 17 Y	225/40/245/35 R 18 Y	195/55 R 16 H	195/55 R 16 H	195/55 R 16 W ⁷	205/55 R 16 V	205/50 R 17 Y
Wheel dimensions		6.5 J x 16	6.5 J x 16	6.5 J x 16	7 J x 17	7.5 J x 18	6.5 J x 16	6.5 J x 16	6.5 J x 16 ⁷	7 J x 16	7 J x 17
Material		steel	steel	steel	light alloy	light alloy	steel	steel	steel	steel	light alloy

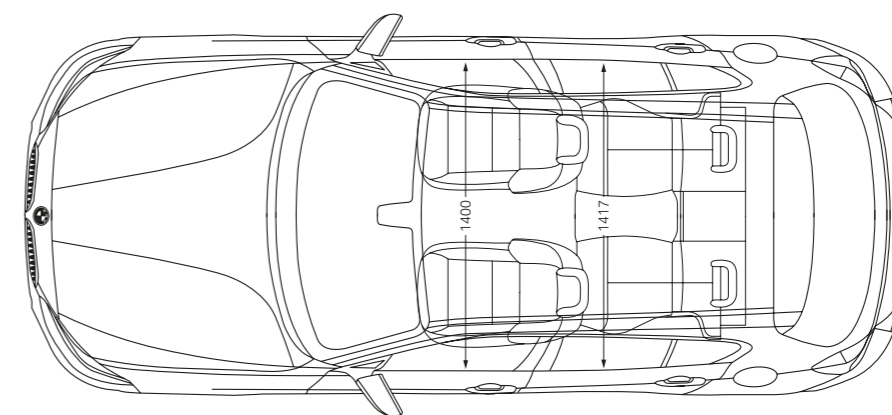
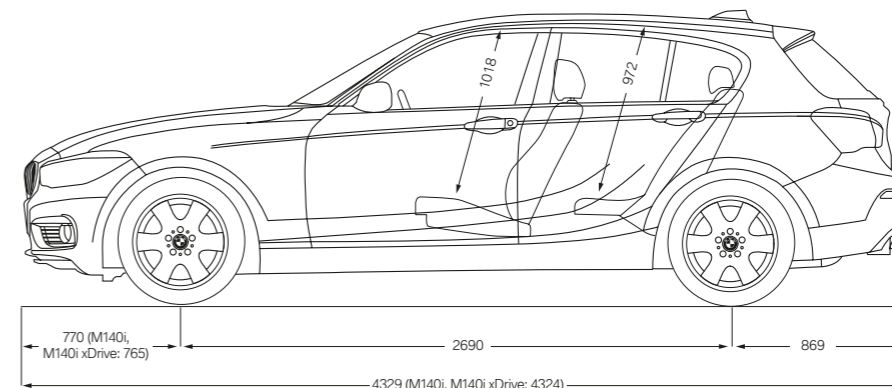
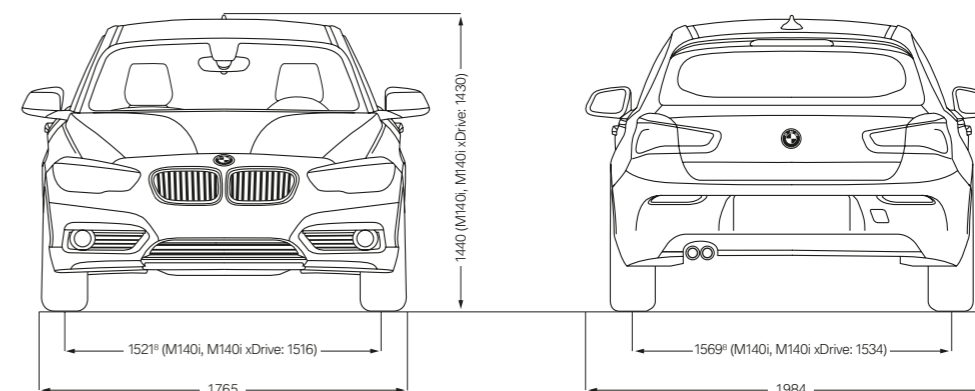

All dimensions in the technical drawings are given in millimetres (shown here on the BMW 1 Series 5-door). Some of the interior dimensions of the BMW 1 Series 3-door vary. Quoted performance, fuel consumption and CO₂ emissions figures refer to vehicles with standard transmission. Figures in [] refer to vehicles with Steptronic transmission.

¹ Figures quoted are based on a 90% full tank, driver weight of 68 kg and 7 kg of luggage. Unladen weight applies to vehicles with standard equipment. Optional equipment may increase these figures.

² The actual total weight of the trailer must not exceed the maximum trailer load, taking into account the maximum tow bar download.

³ BMW recommends the use of RON 95 super unleaded petrol. Unleaded RON 91 and higher with a maximum ethanol content of 10% (E10) may also be used. Performance and fuel consumption data apply to vehicles using RON 98 fuel.

⁴ All engines comply as standard with the EU6 exhaust emissions standard. Fuel consumption is determined in accordance with the ECE driving cycle. This is made up of approximately one-third urban and two-thirds extra-urban driving (based on distance covered). CO₂ emissions are measured in addition to fuel consumption. Optional equipment may increase these figures. Fuel consumption and CO₂ emission figures are dependent on tyre format (higher figures refer to models with optional wheels). For further information on fuel consumption and CO₂ emissions, please contact your BMW partner.

⁵ Electronically limited.

⁶ Maximum torque for the Steptronic transmission of 270 Nm at 1,350-4,600 rpm.

⁷ Differing value for 118d xDrive. Tyre dimensions 205/55 R16 V; wheel dimensions 7J x 16.

⁸ Different front track width for 125i, 120d and 125d: 1521 mm. Different rear track width for 125i, 120d, 125d, 118d xDrive and 120d xDrive: 1556 mm.

⁹ Different permitted unbraked trailer load for the 125d 3-door: 740 kg.

BMW 1 Series 5-DOOR M140i xDrive EDITION SHADOW:

M Performance TwinPower Turbo 6-cylinder petrol engine, 250 kW (340 hp), 18" M light alloy wheels Double-spoke style 719 M Jet Black, exterior colour in Estoril Blue metallic, seats in cloth/Alcantara combination 'Hexagon' Anthracite, interior trim finisher in Aluminium Hexagon with highlight trim finisher Black high-gloss.

BMW 1 Series 3-DOOR 125i EDITION SPORT SHADOW LINE:

BMW TwinPower Turbo 4-cylinder petrol engine, 165 kW (224 hp), 17" light alloy wheels Double-spoke style 725, exterior colour in Melbourne Red metallic, seats in leather 'Dakota' Black with Red highlight, interior trim finisher in black high-gloss with highlight trim finisher in Coral Red matt.

The models illustrated in this brochure show the equipment and configuration options (standard and optional) for vehicles produced by BMW AG for the German market. Alterations in standard and optional equipment and the configurations available for the different models, as described in this brochure, may occur after 09.06.2017, the date when this brochure went to press, or according to the specific requirements of other markets. Your local BMW Partner is available to provide further details. Subject to alteration in design and equipment.

© BMW AG, Munich, Germany. Reproduction, even in part, only with the written approval of BMW AG, Munich.

4 11 001 043 20 1 2017 BM. Printed in Germany 2017.

